

DATE: _____ PROJECT: _____ TYPE: _____

CATALOG NUMBER LOGIC:



**Choose between stainless steel or copper for brass finish.*

***Only available for Brass Material.*

CATALOG NUMBER LOGIC

Example: AR - LS - 14 - LED - 387 - BLP - RAD - A-BLP - 120

MATERIAL

(Blank) - Aluminum B - Brass

SERIES

AR - Arcade

STYLE

LS - Louvers

WALL PLATE

14 - 14 Inch

SOURCE

LED - LED

LED TYPE

387 - 7W LED/2700K 388 - 7W LED/3000K 389 - 7W LED/4000K

FRAME FINISH (See page 2 for full-color swatches)

Standard Finishes (BZP, BZW, BLP, BLW, WHP, WHW, SAP, VER)

Premium Finish (ABP, AMG, AQW, BCM, BGE, BPP, CAP, CMG, CRM, HUG, NBP, OCP, RMG, SDS, SMG, TXF, WCP, WIR)

Also available in RAL Finishes

Brass Finishes (NAT, BP, GP)

DIFFUSER

WHT - Translucent White

ALB - White Alabaster

ROS - Rose Alabaster

HRN - Natural Horn

CAR - Carmel

RAD - Radiant Flame

RINGS & FINISH (See page 2 for full-color swatches)

A - Aluminum Ring

Standard Finishes (BZP, BZW, BLP, BLW, WHP, WHW, SAP, VER)

Stainless Steel Ring & Finish

S - Stainless Steel Ring*

Standard Finishes (BZP, BZW, BLP, BLW, WHP, WHW, SAP, VER)

Stainless Steel Finishes (NAT, POL)

Copper Rings & Finish*

C - Copper Rings

Copper Finishes (NAT, BP, GP, POL)

VOLTAGE

120V or 277V

OPTION**

CLR - Clear Coat Protection (Available on NAT or POL finish only)

DATE:

PROJECT:

TYPE:

FRONT VIEW

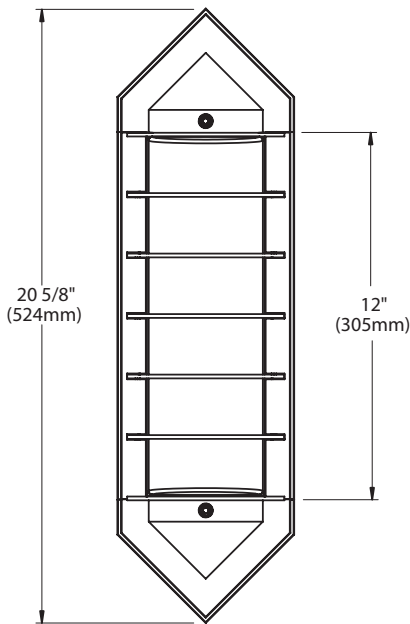

SIDE VIEW

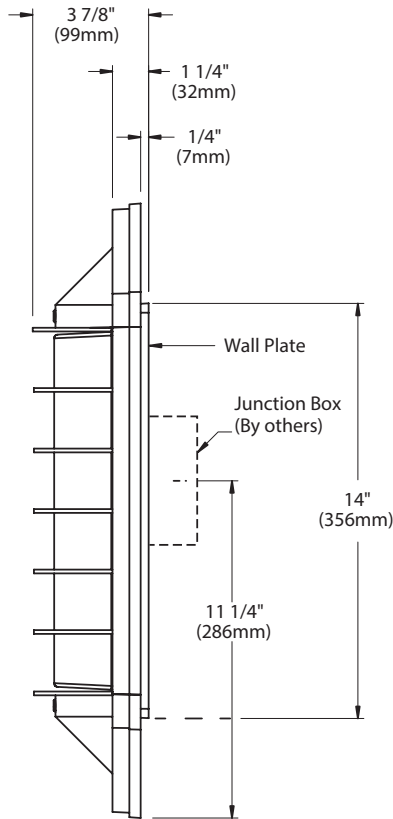

TOP VIEW

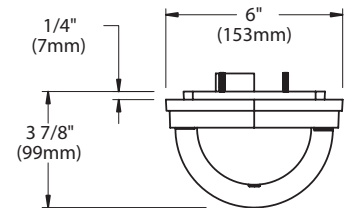

TRANSFORMER

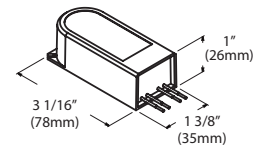

STANDARD FINISHES



PREMIUM FINISHES





[Click Here](#) to view larger, full-color swatches of all available finishes on our website.

DATE:	PROJECT:	TYPE:
-------	----------	-------

ACCESSORIES (Configure separately)

SPECIFICATIONS

ELECTRICAL	WATTAGE	7W LED
	SOURCE	LED featuring LED technology (50,000 Hr. Life), 7W LED. Available in 2700K, 3000K and 4000K.
	WIRING	Teflon® coated wire, 18AWG, 300V, 150° C rated and certified to UL 1659 standard.
	TRANSFORMER	Includes a 12 VAC LED transformer. 120V or 277V.
PHYSICAL	MATERIALS	Constructed from copper-free aluminum, corrosion resistant brass, copper and stainless steel. These lifetime materials are inherently corrosion resistant. Factory-applied finishes are also available.
	FACEPLATE	Cast from solid, copper-free aluminum or corrosion resistant brass with stainless steel fasteners.
	RINGS	Constructed from solid copper-free aluminum, copper or stainless steel.
	WALL PLATE	Cast from solid, copper-free aluminum. Fully gasketed, and mounts to a recessed 4" octagonal junction box.
	DIFFUSER	One of 6 standard molded, etched acrylic translucent diffusers for high transmittance and long life.
	HARDWARE	Tamper-resistant, stainless steel hardware with black oxide finish.
	FINISH	<p>Copper and Brass: Natural (NAT): Copper and brass components are sand blasted to expose the porous metal surface. Over time, and with exposure to the elements, the metals will naturally 'weather' resulting in a unique patina.</p> <p>Also available with hand-crafted metal finishes including brown patina (BP), green patina (GP), and polish (POL).</p> <p>Aluminum, copper and stainless components are also available in powder coat finishes.</p> <p>Optional ceramic clear coat protection (copper and brass components only) seals and protects underlying metals and protects against discoloration, fading, and wear. Highly impervious to chemicals, solvents, and graffiti. For use with natural (NAT) and polish (POL) finishes.</p> <p>Aluminum: StarGuard®, our exclusive RoHs compliant, 15 stage chromate-free process cleans and conversion coats aluminum components prior to application of Class 'A' TGIC polyester powder coating.</p>
	WARRANTY	5 year limited warranty.
	LISTINGS	UL tested to IESNA LM-79. UL Listed. Certified to CAN/CSA/ANSI Standards. RoHs compliant. Suitable for indoor or outdoor use. Suitable for use in wet locations. Additionally suitable for installation within 4' of the ground. IP66 Rated. Made in USA.
	  	

LAMP & TRANSFORMER DATA

DATE: _____ PROJECT: _____ TYPE: _____

TRANSFORMER DATA

AC Input Range	Output Range	Frequency Hz	Power Factor At Full Load (Efficiency)	THD	Operation Ambient Temperature
120V	12V	50/60 Hz	> 0.98	<13%	-10°F to 130°F (-23°C to 54°C)
277V	12V	50/60 Hz	> 0.97	<13%	-10°F to 130°F (-23°C to 54°C)

LM79 DATA

LM70 DATA

TEKA LED #	LUMENS (Delivered)	CCT	INPUT WATTS (Typ.)	CRI (Typ.)	Minimum Rated Life (hrs.) - 70% of initial lumens (L70)
387	142	2700	7	90	50,000
388	178	3000	7	80	50,000
389	146	4000	7	90	50,000